



OPERATIONS **GUIDE**

MARK IV TANK FLOOR SCANNER



- **LIGHTWEIGHT**
- **RUGGED**
- **RELIABLE**

Rev. 5



CONTACT US :

150 Holder Lane
Dripping Springs, TX, 78620
Web: www.mfeenterprises.com
Phone: (281) 441-8284

MARK IV TANK FLOOR SCANNER



THE MARK IV TANK FLOOR SCANNER OPERATIONS GUIDE

SAFETY NOTICE

This equipment makes use of very powerful rare earth magnets. Great care should be exercised when disassembling the unit or moving the magnetic bridge to prevent damage to either the operator or equipment.

This equipment should only be handled and operated by personnel who have received the necessary training from MFE ENTERPRISES, INC. Should it be necessary to unpack the transportation case prior to any training, please note that this equipment uses **very powerful magnets** that can be hazardous if mishandled and the equipment itself can be damaged. The magnetic bridge is mounted to a keeper plate in the transportation case for shipping purposes and should not be disturbed prior to the arrival of the MFE-trained personnel.

It is strongly recommended to fully charge the unit prior to use. **Do not use any battery chargers other than the ones provided to charge this equipment.**



TANK SETUP

CHECKLIST

- 1 Remove Handle Assembly from case.
- 2 Attach Handle Assembly to Bridge Assembly (with bridge on keeper plate).
- 3 Attach all 3 cables.
- 4 Adjust Sensor Bar to the #1 Setting.
- 5 Press Power Button to Turn On Scanner (should automatically boot into Mark 4 Software).
- 6 Select Manual Tab in software.
- 7 Select Configuration Screen and adjust plate thickness to 1/2" and coating thickness to 0 (Keeper plate is 1/2" thick and requires this change to perform function test).
- 8 Scan Keeper Plate to verify that you receive a signal response on all 12 channels.
- 9 Select Configuration Screen and adjust plate/coating thickness to match conditions of tank floor.
- 10 Adjust Sensor Bar to the #3 Setting.
- 11 Remove scanner from keeper plate and place scanner on tank floor.
- 12 Adjust Sensor Bar to the lowest setting possible without it scraping the tank floor on a consistent basis.

SCANNER IS READY TO BEGIN TANK FLOOR INSPECTION!

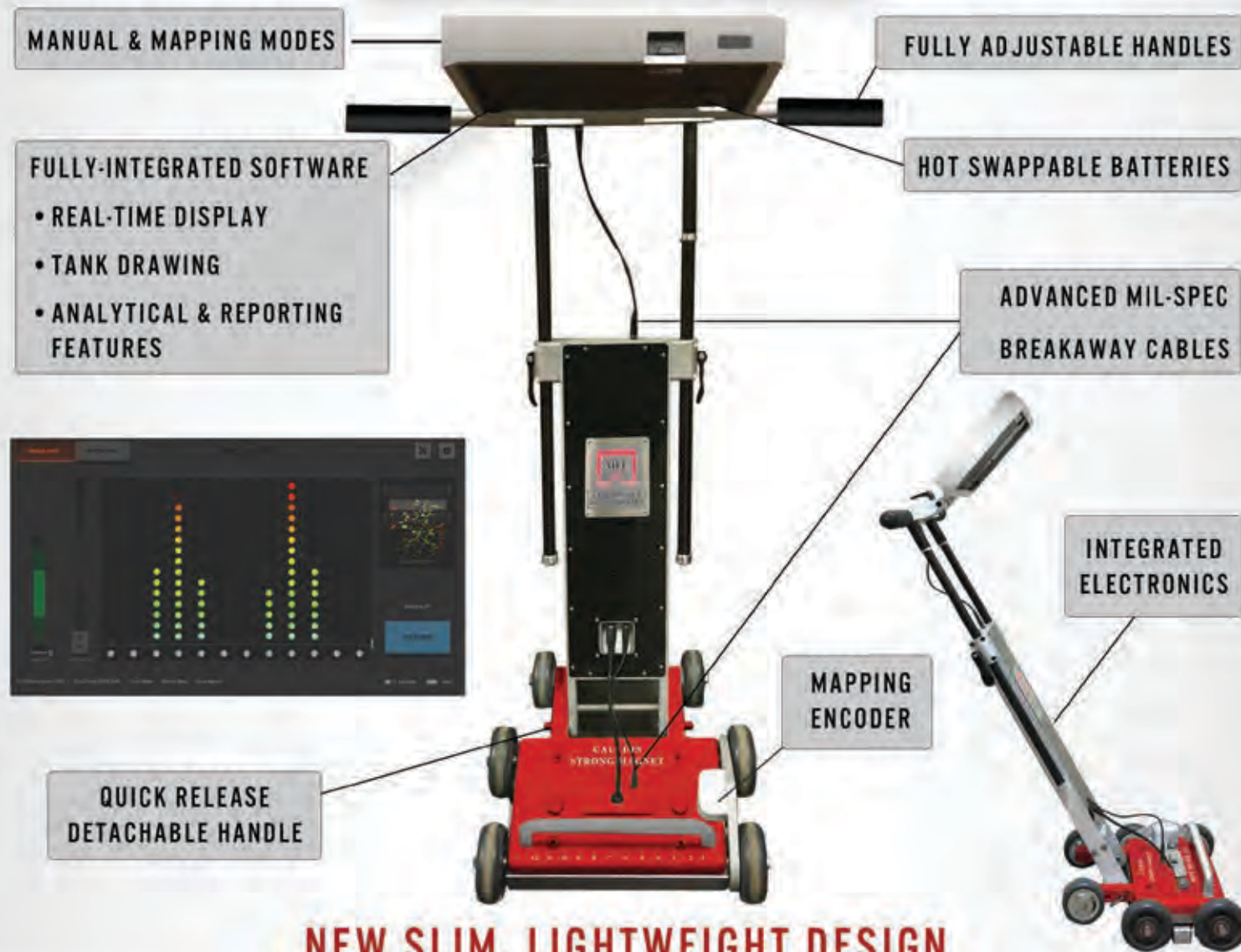
MARK IV TANK FLOOR SCANNER

INTRODUCTION

The content of the Mark IV Tank Floor Scanner Operations Guide is intended to provide guidance during setup, assembly, and to familiarize operators with the various parts of the Mark IV. **It is not a substitute for the Mark IV Training Course that is necessary for the proper use of the MFE Mark IV Tank Floor Scanner.**

The Mark IV uses Magnetic Flux Leakage as a detection tool. The powerful magnetic bridge allows for saturation of the inspected material. Any localized reduction in the thickness of the inspected material will result in a flux leakage at the surface. A series of sensors are placed between the poles of the magnetic bridge to detect these leakage fields. The strength of the leakage field is a function of volume loss and is not a reliable indication of remaining wall thickness. Although the amplitude of the signal generated by the sensors gives some relative severity information, it is not recommended that amplitude alone be used for accept/reject criteria purposes. Flux leakage should only be used as a detection tool. Quantitative information can only be obtained using ultrasonic assessment of the areas identified by the magnetic flux leakage scanner.

MARK IV DIAGRAM



CASE CONTENTS



LARGE CASE WITH HANDLE ASSEMBLY

EQUIPMENT ID NUMBER

Each case exterior displays the ID number of the equipment it carries.



Before removing the Mark IV Handle Assembly from the case, remove the battery charger and foam insert. Remember the location of these items for proper repackaging of equipment.

HANDLE ASSEMBLY

OPERATION GUIDES & USB DRIVE

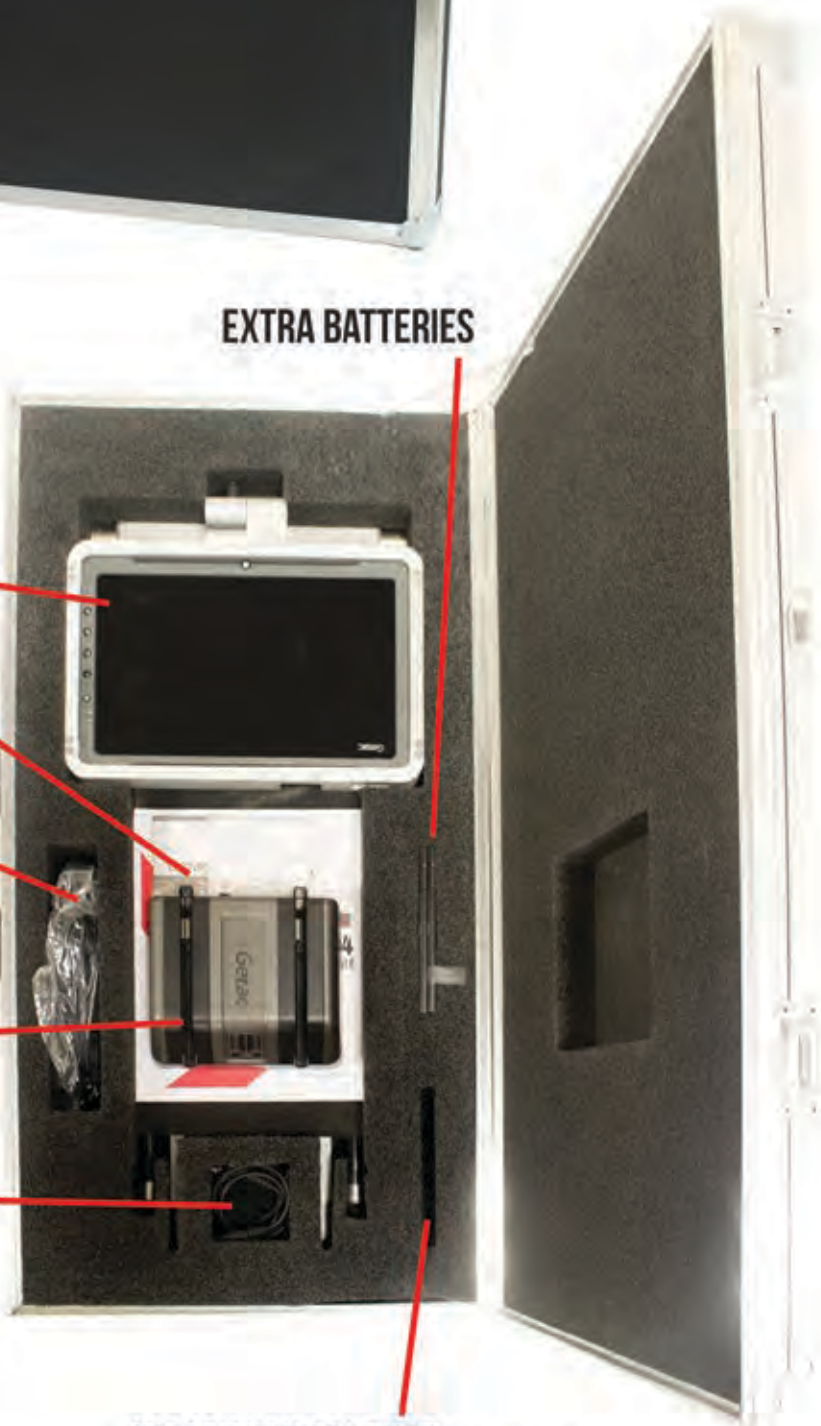
AC ADAPTER & BATTERY CHARGER POWERCORD

BATTERY CHARGER

CABLE STORAGE:

1. ELECTRONICS CABLE
2. ENCODER CABLE
3. SIGNAL CABLE

EXTRA BATTERIES



SPACE AVAILABLE FOR ADDITIONAL BATTERY STORAGE

CASE CONTENTS



LARGE CASE WITH HANDLE ASSEMBLY

GETAC BATTERY CHARGER
OPERATION GUIDE

GETAC BATTERY PACK
USER GUIDE



MARK IV TANK SCANNER
OPERATIONS GUIDE

EXTRA BATTERY #1



EXTRA BATTERY #2



MICROFIBER SCREEN
CLEANING CLOTH

TOUCHSCREEN COMPATIBLE GLOVES



GETAC TABLET
REFERENCE GUIDE

ENCODER
CABLE



BATTERY CHARGER



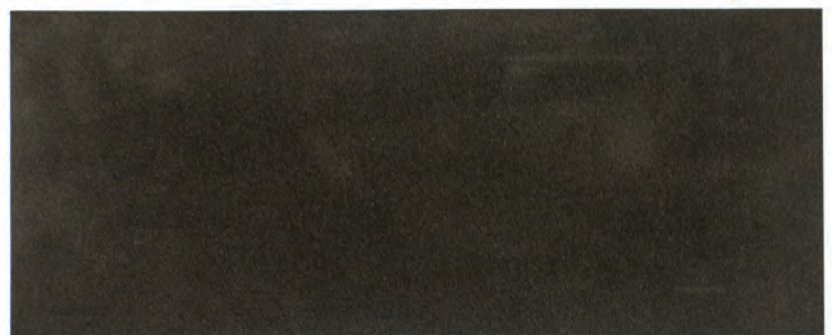
USB DRIVE



AC ADAPTER



REMOVABLE FOAM INSERT



SIGNAL CABLE



ELECTRONICS CABLE



CASE CONTENTS & ASSEMBLY



SMALL CASE CONTAINING BRIDGE

MAGNETIC BRIDGE

EQUIPMENT ID NUMBER

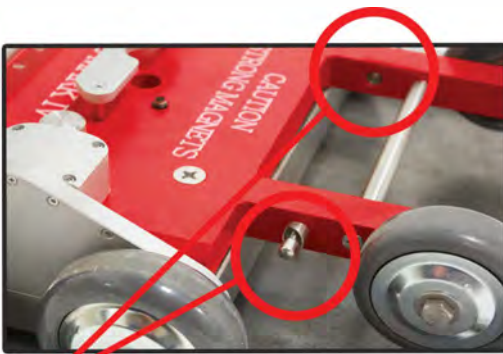
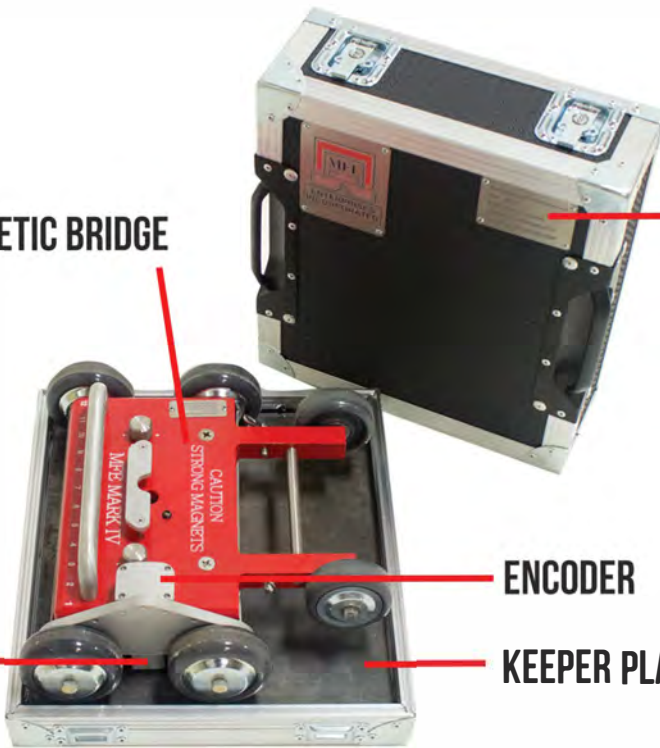
The large and small cases have matching equipment ID numbers that coincide with the equipment ID of the enclosed Mark IV Tank Floor Scanner.

ENCODER

KEEPER PLATE

The keeper plate serves a dual purpose of containing the magnetic field for shipment purposes and function testing the equipment using a series of side-by-side defects.

SENSOR BAR



QUICK-RELEASE PINS ATTACH THE HANDLE BAR ASSEMBLY TO THE BRIDGE ASSEMBLY

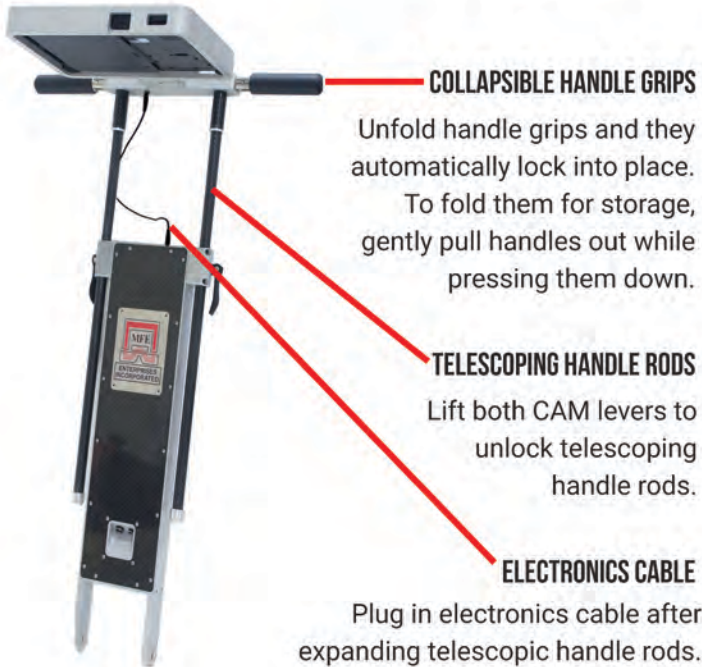
Attach the handle to the bridge by adjusting the lever to the correct position and allow the quick-release pins to lock into place.

When ready to **detach** the handle, gently raise the top of the handle while rotating the levers 180 degrees.



HANDLE ASSEMBLY

PARTS & CABLE SETUP



Turn lever counterclockwise to unlock tablet holder. Set tablet at desired angle and turn lever clockwise to lock tablet into place.

RECEPTACLE FOR SENSOR CABLE & ENCODER CABLE



MAGNETIC BRIDGE TO HANDLE ASSEMBLY CABLE CONNECTIONS

Connect the signal cable and the encoder cable from bridge to handle by lining up the red dots on the cables and receptacles.

Since the sensor bar is not visible from the top, the cable can be gently pressed in to the receptacle and slowly rotated until the proper alignment is discovered.

POWERING THE TABLET & MARK IV



POWER BUTTON

The green power button is used to turn the power to the tablet (and tank floor scanner) on and off.

Once powered on, the Mark IV Scanner Software will automatically boot up as your home screen. In the event that the software fails to boot up, then press the green button to power off the tablet and then turn the power back on.

Powering up the software may take 1-2 minutes.

HOT SWAPPABLE BATTERIES

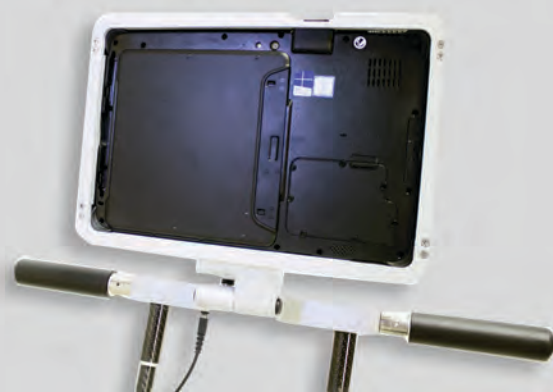


The tablet batteries power both the GETAC tablet as well as the entire Mark IV Tank Floor Scanner. Operators are able to replace one battery at a time with no power interruption to the Mark IV.

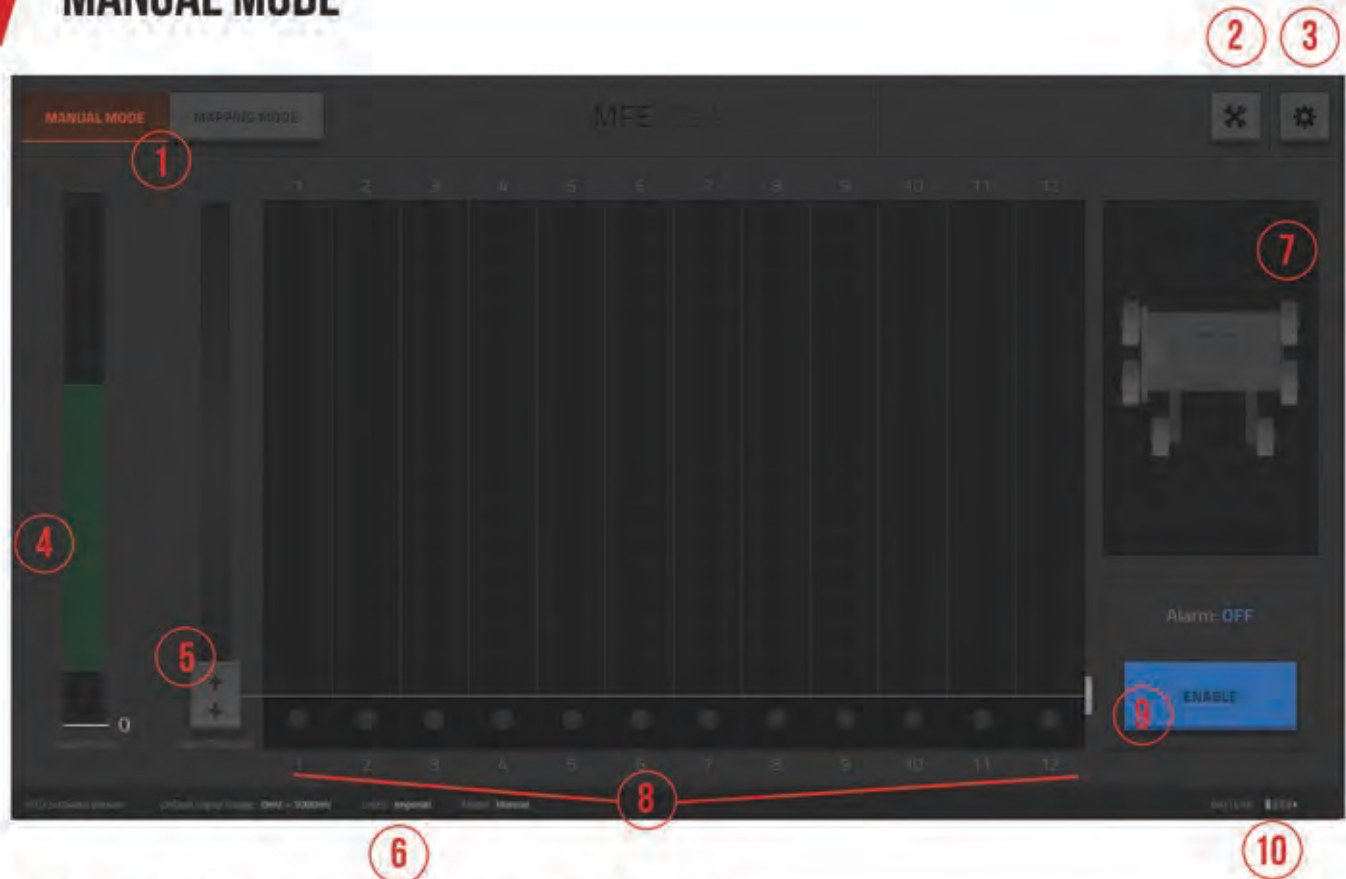
When replacing the batteries, insert the side opposite of the clear tab first and push in the interior side adjacent to the yellow tabs second. When inserted the clear tabs on each battery will be on the same side as the yellow tabs.

Pressing the power buttons located directly on each battery will light up a battery power indicator.

For additional details on the tablet, please refer to the GETAC F110 Operation Guide included with the scanner.



MANUAL MODE



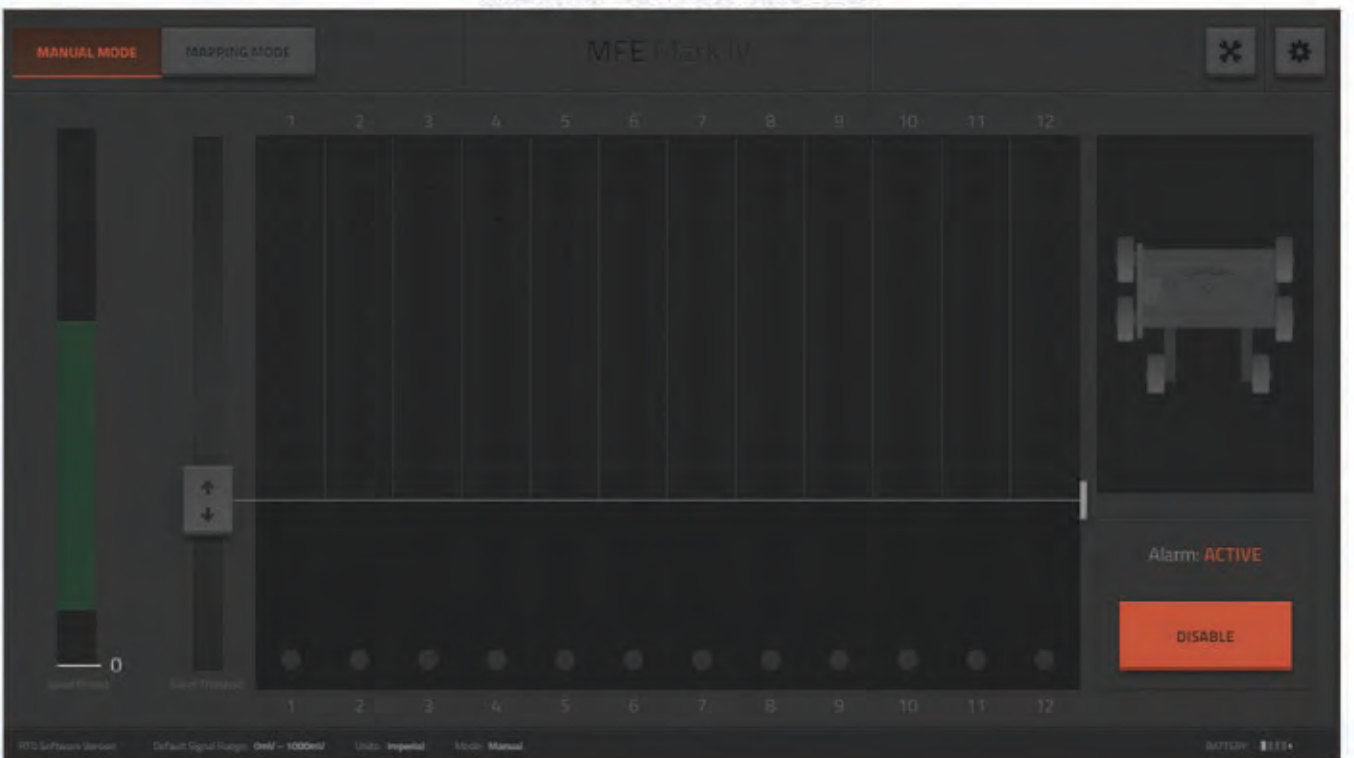
- 1 Displays current mode of operation: Manual or Mapping.
- 2 Plate and Coating Configuration – Options for changing the settings for different plate and coating thickness (Image 5).
- 3 General Settings – Select between Imperial and Metric (Image 6).
- 4 **Speed Meter:** Displays speed at which scanner is moving. All signals generated inside the green zone are speed-corrected; signals generated outside the green zone are not.
- 5 **Alarm Threshold:** Active when the alarm is on. Slide the bar to the desired position. Once the signal reaches this level, the alarm will trigger with a red screen (See Image 2).
- 6 Displays measurement system currently selected in the configuration screen: imperial or metric.
- 7 C-Scan Type Image – Overhead display of signals used to easily locate defects. Move your thumb and pointer finger away from each other to zoom in, and "pinch" them together to zoom out (Image 5).
- 8 12 Channel Real Time Display (RTD) – 12 Channel display of the MFL signals generated by the scanner.
- 9 **Alarm Enable / Disable:** Click to enable/disable Alarm Mode. The alarm is triggered once the signal reaches the threshold level (Image 3). In the event that the threshold is set too low and the alarm constantly triggers when reset, swap mapping mode and back to manual mode.
- 10 Battery Level – Current level of the GETAC F110 batteries.

MANUAL MODE

IMAGE 2 - ALARM TRIGGERED

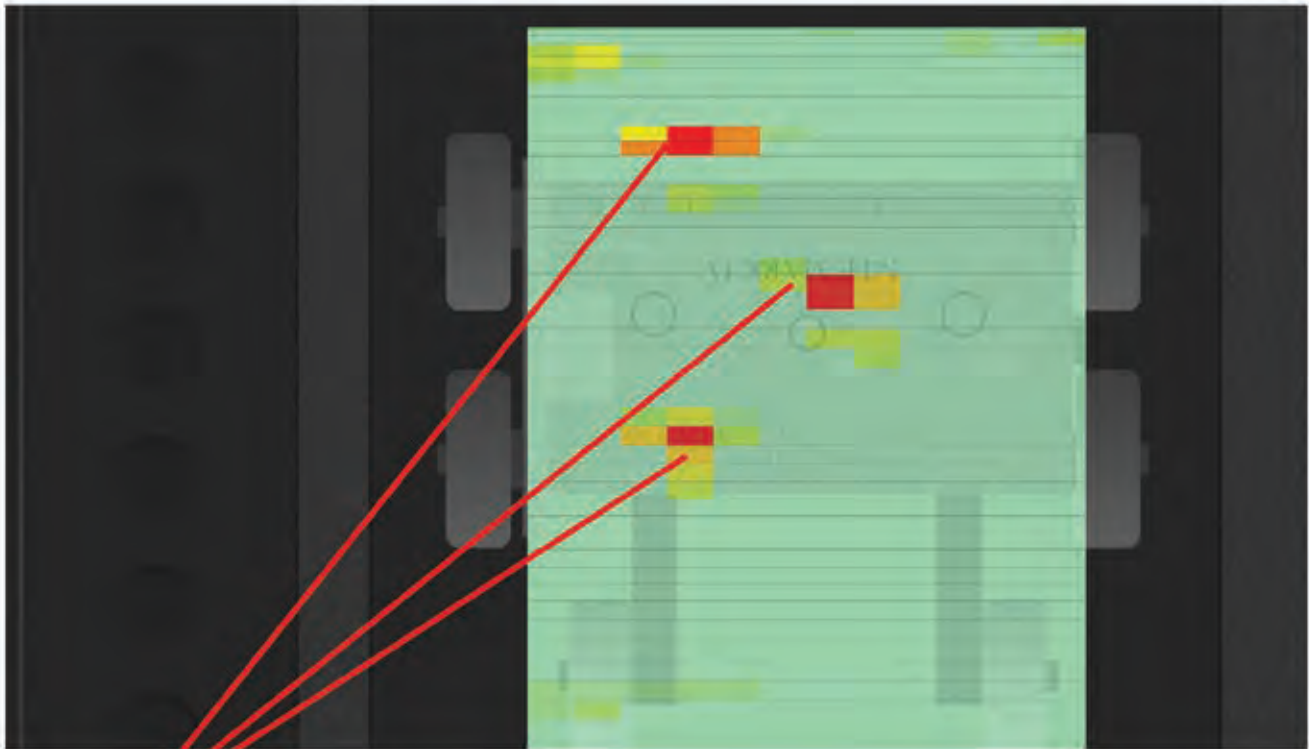


IMAGE 3 - ALARM ENABLED



MANUAL MODE

IMAGE 4 (ZOOMED IN ON OVERHEAD SCAN)



DEFECT SIGNALS

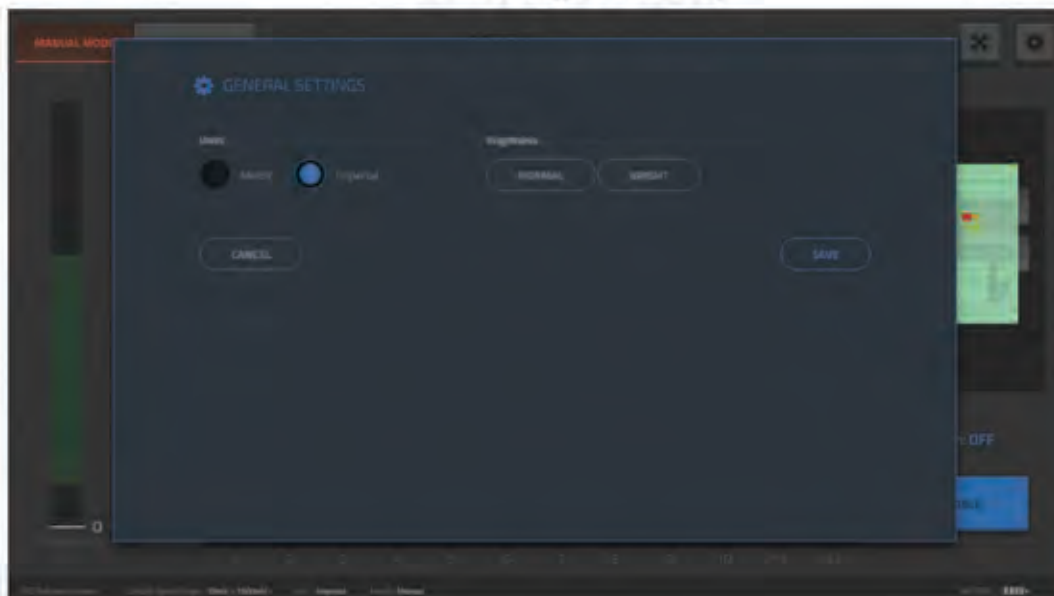
MANUAL MODE

IMAGE 5 (PLATE AND COATING SETTINGS)



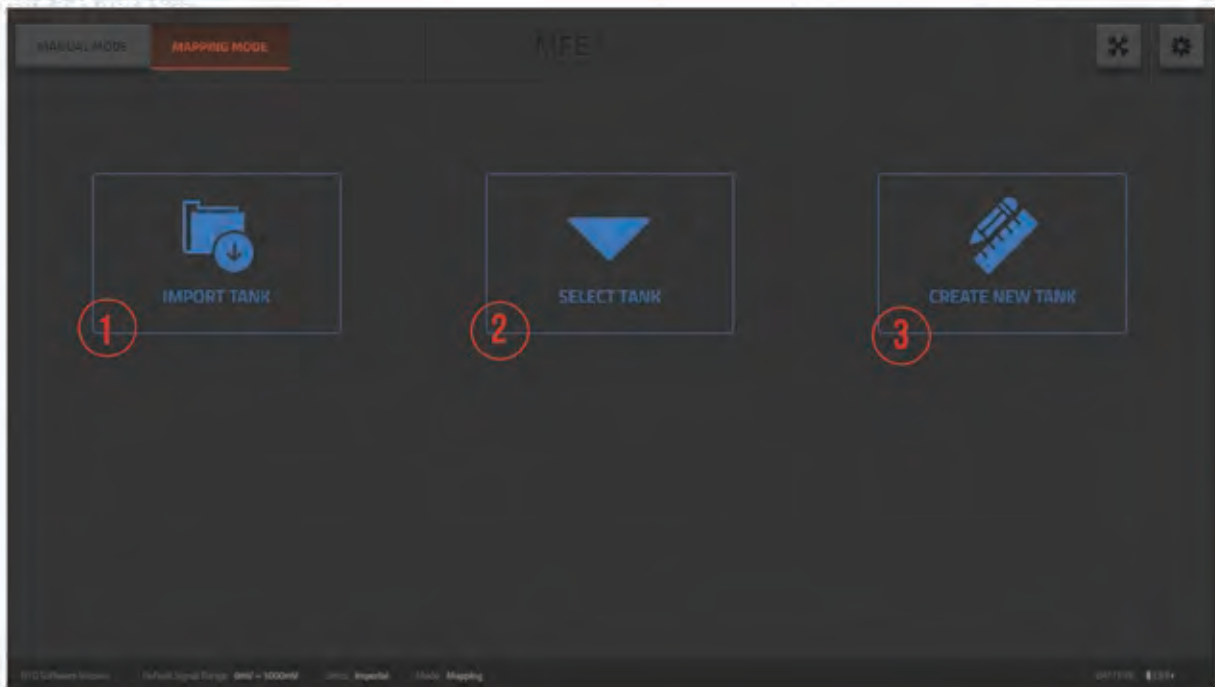
- 1 SELECT PLATE THICKNESS:** Selecting the plate thickness will adjust the signal response accordingly.
- 2 COATING THICKNESS:** Selecting the thickness of coating will adjust the signal response accordingly.
- 3 SIGNAL:** For advanced users. Signal is adjusted by coating and plate thickness selection. Operator can change signal for less or more signal strength. The lower the mV number, the more signal strength. The higher the number, the less signal strength.

IMAGE 6 (SETTINGS)



MAPPING MODE

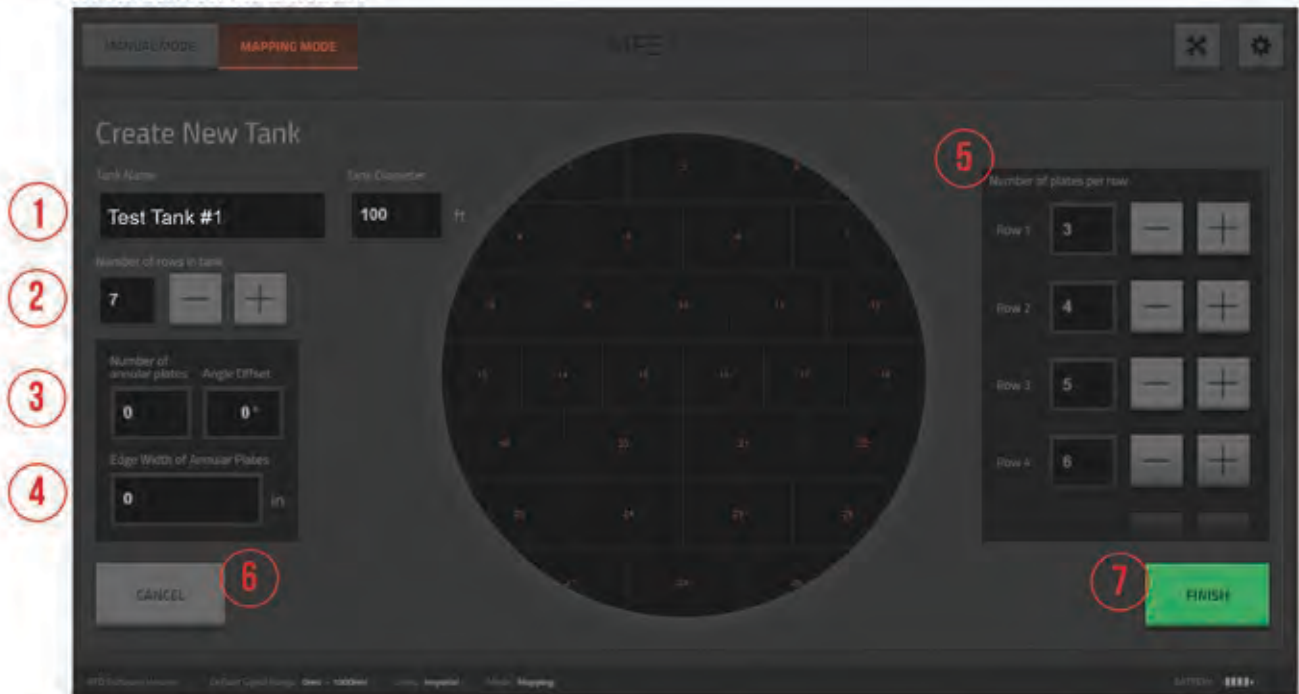
HOME SCREEN



- 1 Select 'Import Tank' to import a previously saved tank from a USB Drive.
- 2 Choose the 'Select Tank' option to go to a menu that lists your previous tanks.
- 3 Selecting 'Create New Tank' takes you to the tank creation screen before scanning a new tank.

MAPPING MODE

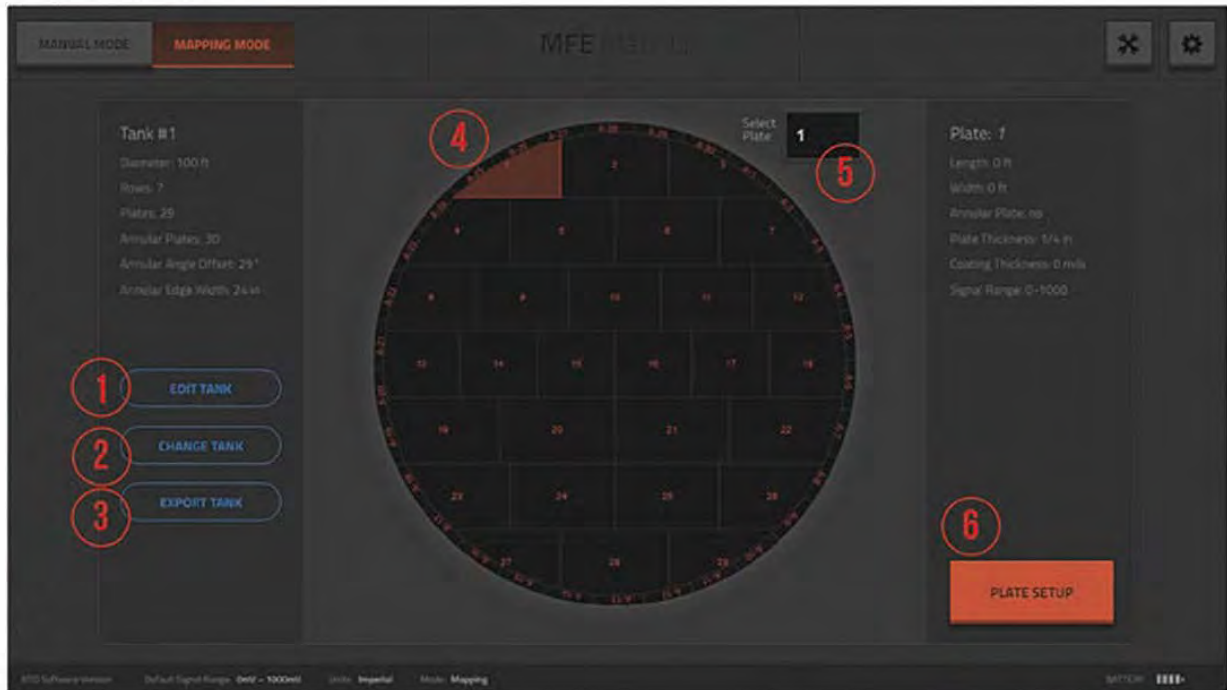
TANK CREATION SCREEN



- 1 **TANK NAME and DIAMETER:** Enter a name and the diameter of your tank.
- 2 **NUMBER OF ROWS IN TANK:** Use the plus and minus buttons to input your rows or directly input them using the virtual keyboard.
- 3 **NUMBER OF ANNULAR PLATES & ANGLE OFFSET:** Enter the number of annular plates around your tank. 'Angle Offset' allows the operator to shift the angle of the tank diagram to better reflect the tank being scanned.
- 4 **EDGE WIDTH OF ANNULAR PLATES:** Enter the edge width of annular plates to adjust their appearance in the tank diagram.
- 5 **NUMBER OF PLATES PER ROW:** Enter the number of plates per row here. To access additional rows, swipe up or down on the row section on the screen.
- 6 **CANCEL:** Clicking the cancel button will take you to the home screen. By clicking cancel before finishing your tank, you will restart the tank creation process and your work will not be saved.
- 7 **FINISH:** When your tank details have been entered, click Finish to save your tank.

MAPPING MODE

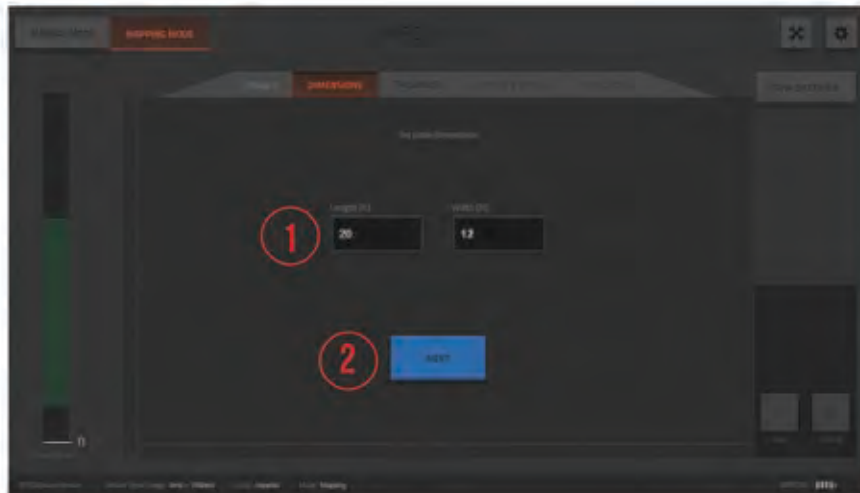
PLATE SELECTION



- 1 EDIT TANK:** The 'Edit Tank' option allows you to revert back to the 'Tank Creation Screen' to make adjustments to your tank details.
- 2 CHANGE TANK:** Select this option to switch to a previously created tank file.
- 3 EXPORT TANK:** Select 'Export Tank' to save your tank to a USB drive. **This feature will be used to export the final inspection report.**
- 4 PLATE SELECTION USING DIAGRAM:** Touch the plate within the tank diagram on the screen you would like to scan.
- 5 SELECT PLATE:** You may also enter the plate number that corresponds with the plate you are going to scan here by using the virtual keyboard.
- 6 PLATE SETUP:** When you have completed creating your tank and are ready to begin scanning your first plate, choose 'Plate Setup.' **Once Plate Setup is selected and you begin scanning, you will not be able to make changes to your tank diagram.**

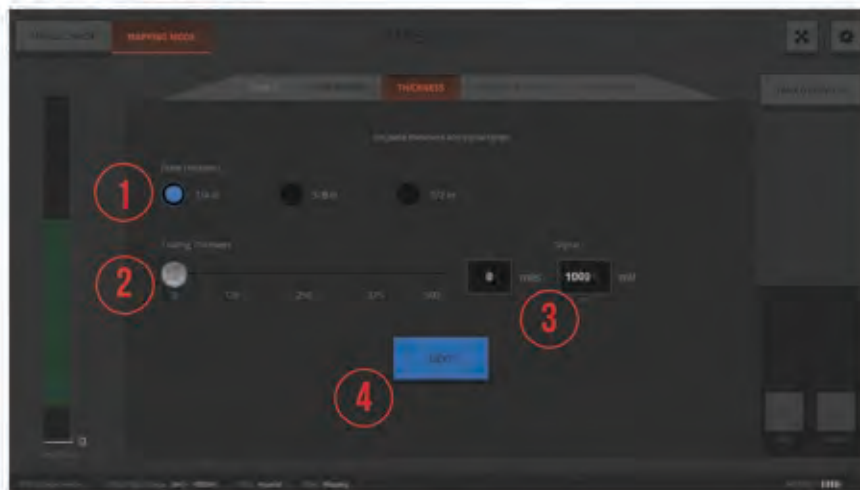
MAPPING MODE

PLATE DIMENSIONS



- 1 Enter the length and width of your plate on this screen.
- 2 Click NEXT to move onto the next screen.

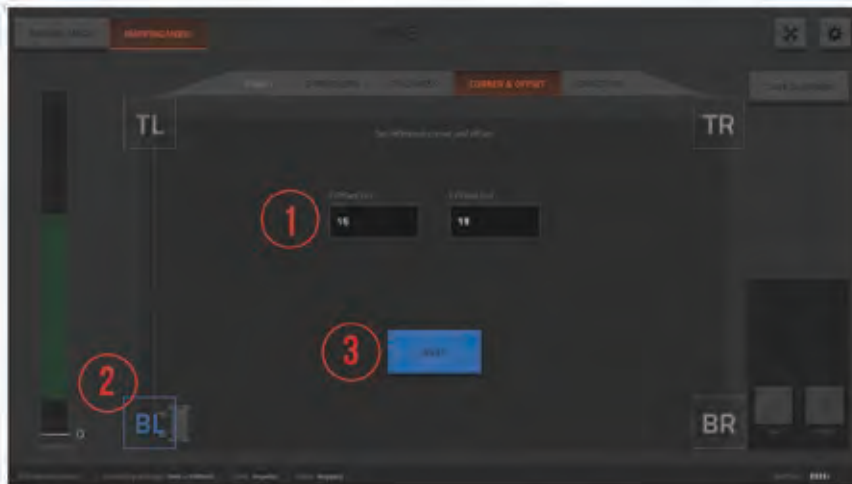
COATING THICKNESS



- 1 Select your plate thickness here.
- 2 Enter coating thickness here.
- 3 Selecting plate thickness and coating thickness will determine a preset signal range. This range can be manually adjusted here.
- 4 Click NEXT to move onto the next screen.

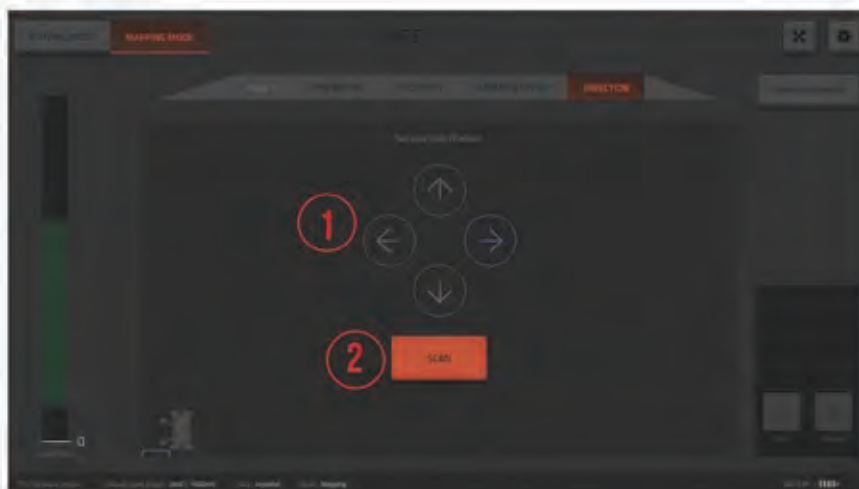
MAPPING MODE

CORNER & OFFSET



- 1 You may offset the location of the bridge by entering its specific location on the X and Y axis of the plate here.
- 2 Select your reference corner on the plate by touching BL (Bottom Left), BR (Bottom Right), TL (Top Left), or TR (Top Right).
- 3 Click NEXT to move onto the next screen.

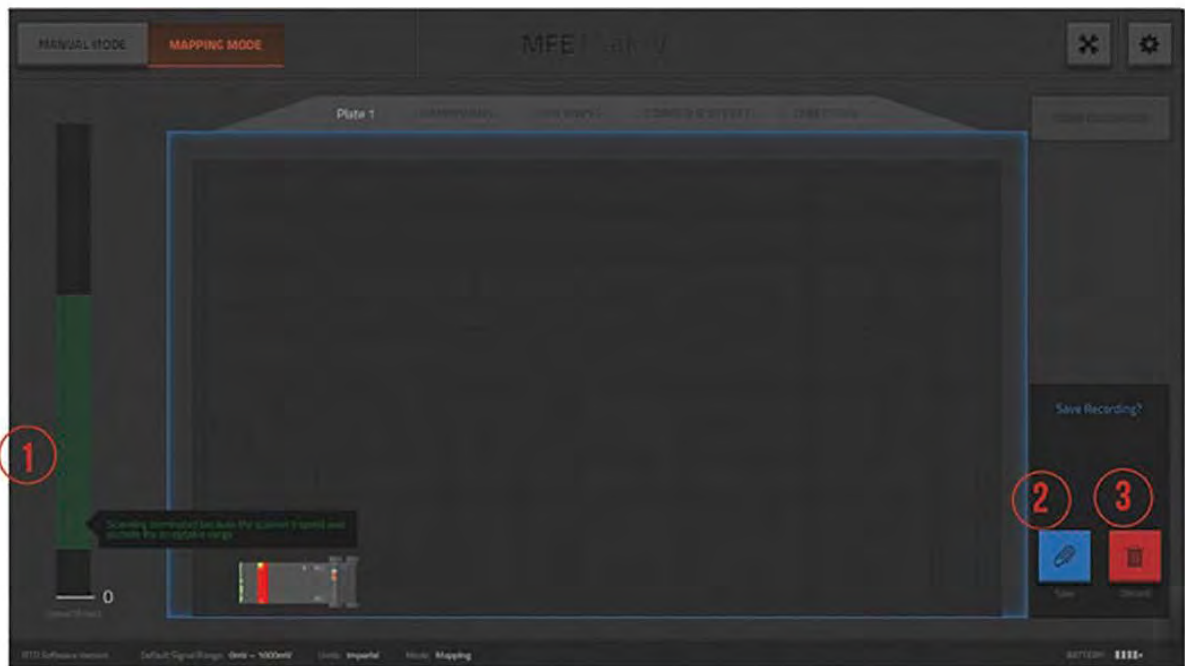
SCANNING DIRECTION



- 1 Select your scanning direction on the 'Direction' screen.
- 2 This is the final selection of the plate setup process. You may now select 'Scan' and begin scanning the plate.

MAPPING MODE

SCANNING A PLATE



- 1 SPEED TRACKING:** The scanner will begin recording when the speed reaches the green zone. It will automatically stop recording when the speed exits the green zone (too fast, too slow, or stops). Speed Compensation Software allows operators scanning at different speeds to obtain the same results. The signal response is normalized when scanning within the speed tracking range.
- 2 DISCARD TANK:** Select the discard button to discard your data and scan the plate again.
- 3 SAVE:** Select this option once you've completed scanning your plate to save the data.

Replacing the Timing Belt

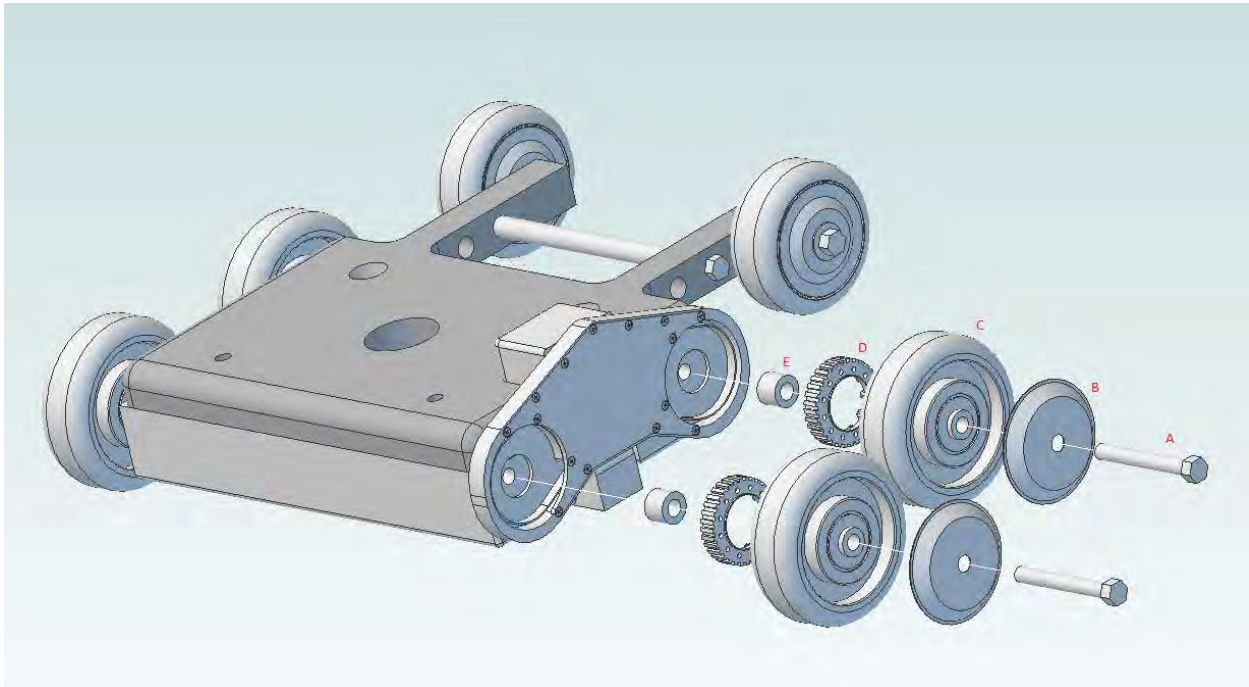
Rev-1

Recommended tools: 9/16" Wrench, #1 Phillips Screwdriver, Clean Cloth Rag, & Vacuum Cleaner

Step 1: Place magnetic bridge in a location free from metal objects (ideally a wood workbench).

Tip: Placing the magnetic bridge pole pieces on two wood blocks can help with this maintenance by taking the weight off the wheels.

Step 2: Remove the wheels on the same side as the timing belt housing (see below illustration).

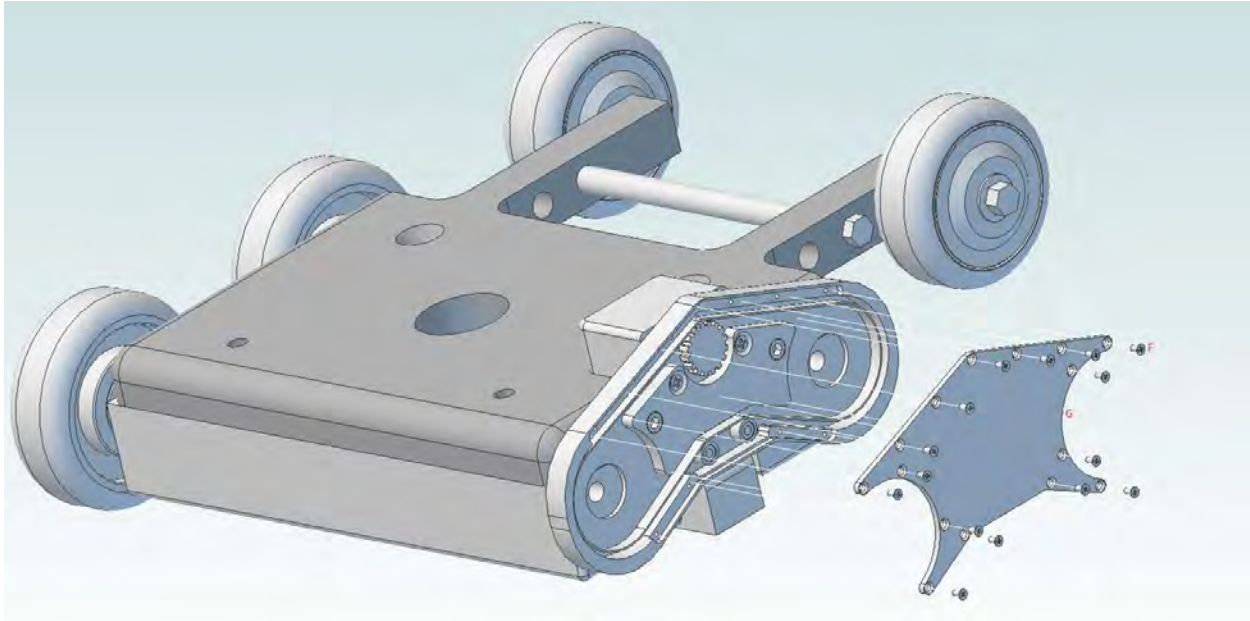


Parts:

- A) 3/8"-16 Grade 9 bolt, 3" length
- B) Wheel cover, zinc plated
- C) 4" Diameter bridge wheel, 1.375" width, solid elastomer castor
- D) Aluminum wheel sprocket, attached to bridge wheel via ten 4-40 phillips machine screws
- E) 3/4" Aluminum spacer, 19/32" length

Rev-1

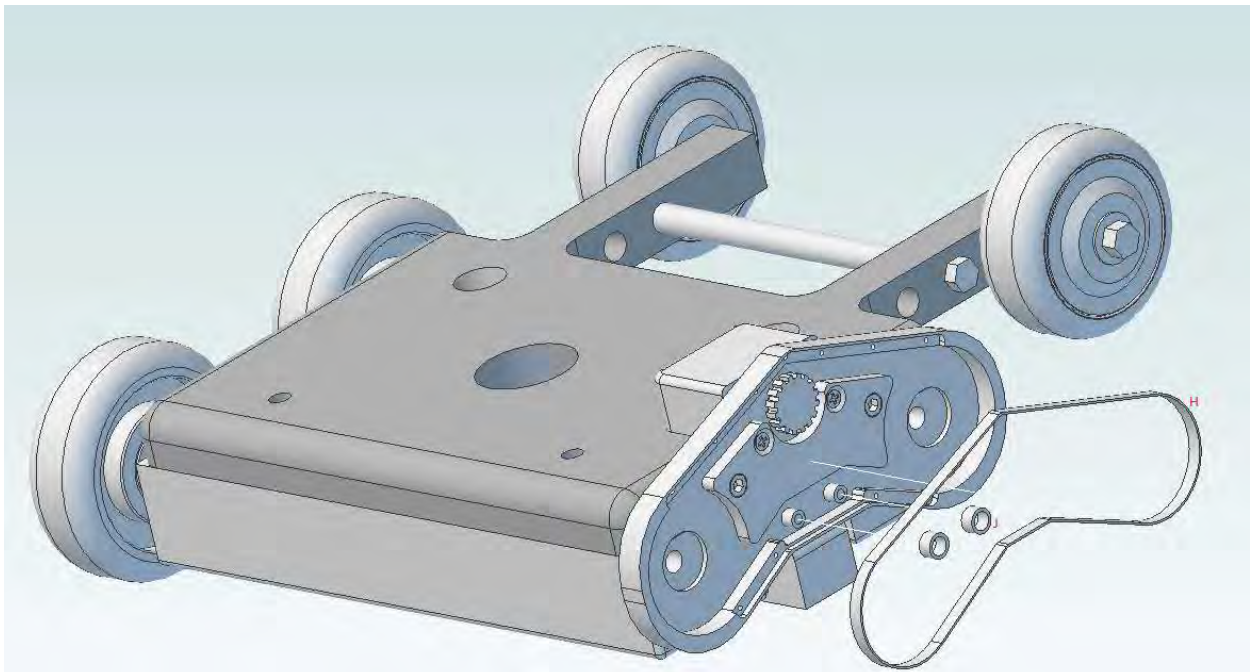
Step 3: Remove the screws holding the timing belt housing in place (see below illustration)



Parts:

- F) 4-40 Flathead machine screw, 0.25" length, stainless steel
- G) Aluminum cover plate for timing belt housing

Step 4: Remove the timing belt and the two bronze bearings (see below illustration)



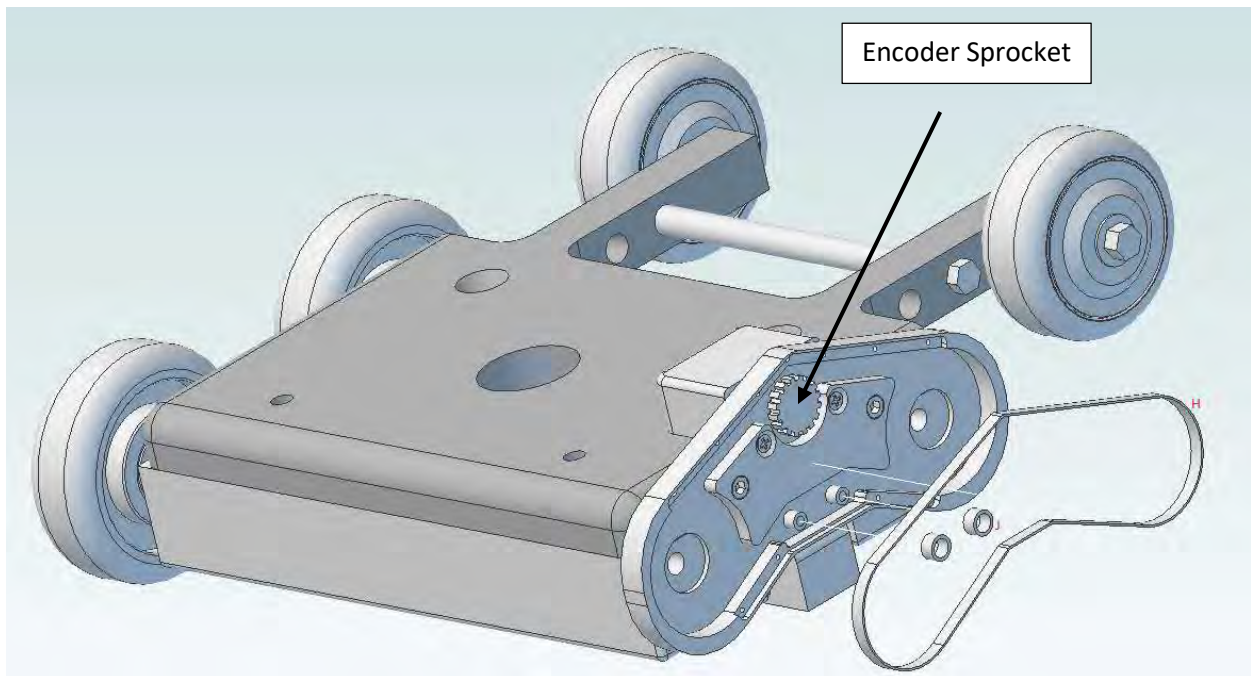
- H) Timing belt
- J) 7/16" Bronze bearing, 0.25" length

Rev-1

Step 5: Clean/vacuum the inside of the timing belt housing until it is free of debris.

IMPORTANT NOTE: If any removed parts need to also be cleaned, use a dry or damp rag to remove any excessive dirt (water only on damp rag). Avoid using any chemical cleaning agents since they can potentially interact with the timing belt material to weaken the belt or potentially cause corrosion to occur inside the timing belt housing.

Step 6: Check that the encoder sprocket spins freely (see below illustration)



Step 7: Reattach the two bronze bearings. These bearings are held in place by the timing belt cover plate (Part G) so care must be taken that they do not fall out while completing the reassembly process.

Step 8: Reattach the timing belt (replacing the timing belt is only required if it's broken or damaged).

Step 9: Reattach the timing belt housing cover plate (Part G) using the appropriate screws (Part F).

Step 10: Reattach both bridge wheels using the appropriate parts (see important note below before attempting this step).

IMPORTANT NOTE: Special attention is required to ensure the two wheel sprockets are engaging the timing belt properly. If this is not done properly, the sprockets can pinch the belt resulting in a broken/damaged timing belt when the scanner is operated.

Rev-1

General Cleaning Guidelines

Important note: This section is for cleaning the scanner on an as-needed basis. All the parts referred to in this section are only the exterior parts of the scanner. **Under no circumstance should the internal parts be removed for cleaning using these instructions.**

Most of the metal/painted surfaces on the Mark 4 have been lacquered to help better protect the metal/painted surface. It is recommended applying a small amount of cleaning agent to a clean cloth rag in order to remove dirt from the surface of these parts. Water, paint thinner, and denatured alcohol are all safe to use to clean the scanner in small quantities.

THINGS TO AVOID:

- 1) Do NOT use any cleaning agents on the tablet or carbon fiber parts.
- 2) Do NOT use lacquer thinner on any painted surface.

When cleaning the computer tablet:

- 1) Use a clean rag only!
- 2) It is strongly recommend to use a microfiber cloth that will help prevent surface scratches when cleaning the tablet display screen.
- 3) It is strongly recommended that cleaning agents are NOT used on any tablet surface. This can result in damage to the tablet.
- 4) It is recommended to initially gently remove any larger amounts of dirt with a clean cloth rag, then use a microfiber cloth to more thoroughly clean the remaining smudges on the tablet screen. Do NOT press down when using the microfiber cloth to clean the screen or the dirt will scratch the screen surface.

IMPORTANT NOTE: All Mark 4 scanner tablets are shipped with a screen protector film that is installed over the tablet's display screen. Any noticeable scratches are most likely not on the display screen itself but rather it is on the screen protector film. A replacement screen protector can be order directly from MFE Enterprises, Inc.